

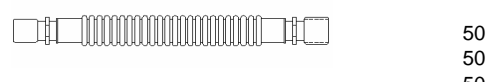

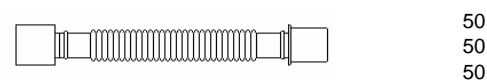

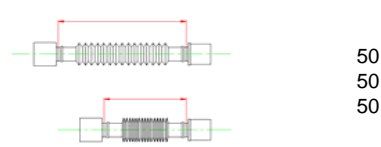

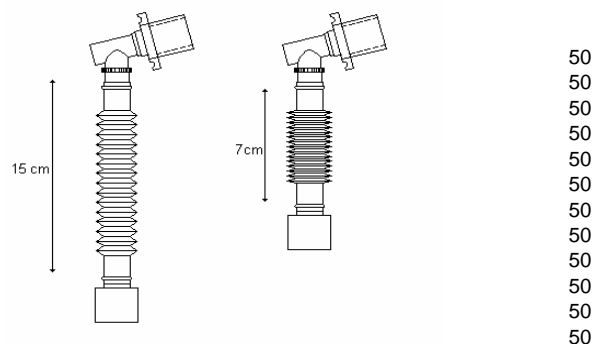

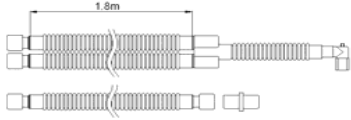
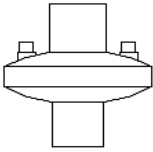
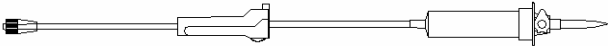



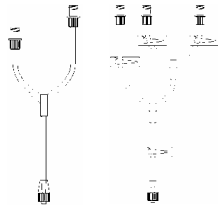
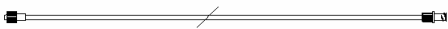







Product Code	Description	unit/box
Catheter Mount		
CM-AO-1010	Collapsible cathetermount with mask elbow 22F end	50
CM-AO-1011	Collapsible cathetermount with swivel mask elbow 22F end	50
CM-AO-1012	Collapsible cathetermount with mask elbow 15M end	50
CM-AO-1013	Collapsible cathetermount with swivel mask elbow 15M end	50
CM-AO-1014	Kink free elastic non-collapsible cathetermount with mask elbow 22F end	50
CM-AO-1015	Kink free elastic non-collapsible cathetermount with swivel mask elbow 22F end	50
CM-AO-1016	Kink free elastic non-collapsible cathetermount with mask elbow 15M end	50
CM-AO-1017	Kink free elastic non-collapsible cathetermount with swivel mask elbow 15M end	50
CM-AO-1018	Collapsible cathetermount with swivel mask elbow 22M/15F end	50
CM-AO-1018-F	Collapsible cathetermount with mask elbow 22M/15F end	50
CM-AO-1019	Flexible cathetermount with swivle mask elbow 22M/15F end	50
CM-AO-1019-F	Flexible cathetermount with mask elbow 22M/15F end	50
Extendable Patient Mount		
CM-AO-1020	Extendable Patient Mount (15F/22F)	50
CM-AO-1021	Extendable Patient Mount (15M/22M)	50
CM-AO-1023	Extendable Patient Mount (15M/22F)	50
Flexible Patient Mount		
CM-AO-1030	Flexible Patient Mount (15F/22F)	50
CM-AO-1031	Flexible Patient Mount (15M/22M)	50
CM-AO-1033	Flexible Patient Mount (15M/22F)	50
High Flow Catheter Mount		
CM-AO-1040	High Flow Catheter Mount (22F/22F)	50
CM-AO-1041	High Flow Catheter Mount (22M/22M)	50
CM-AO-1042	High Flow Catheter Mount (22M/22F)	50
Link Tube		
CM-AO-1050	Link tube (1.0m)	10
CM-AO-1051	Link tube (1.6m)	10
CM-AO-1052	Link tube (2.0m)	10
Mask Elbow		
CM-AO-540	Mask elbow with sampling port	100
CM-AO-542	Swivel mask elbow with sampling port	100
Adult Anaesthesia Breathing Circuit		
CM-AO-2020	1 parallel Y, 2 corrugated tube (2m), 1 mask elbow, 2 end fittings 22F	10
CM-AO-2120	1 parallel Y, 2 corrugated tube (2m), 1 Kink free flexible catheter mount	10
CM-AO-2220	1 parallel Y, 2 corrugated tube (2m), 1 mask elbow, 2 end fittings 22F, 1 link tube (1m) 1 straight connector 22M/M	10
CM-AO-2320	1 parallel Y, 2 corrugated tube (2m), 1 Kink free flexible catheter mount, 2 end fittings 22F, 1 link tube (1m) 1 straight connector 22M/M	10
CM-AO-2220-2	1 parallel Y, 2 corrugated tube (2m), 1 mask elbow, 2 end fittings 22F, 1 link tube (2m) 1 straight connector 22M/M	10
CM-AO-2320-2	1 parallel Y, 2 corrugated tube (2m), 1 Kink free flexible catheter mount, 2 end fittings 22F, 1 link tube (2m) 1 straight connector 22M/M	10
CM-AO-2420	1 parallel Y, 2 corrugated tube (2m), 1 collapsible catheter mount	10
Adult Anaesthesia Breathing Circuit (Collapsible Tube)		
CM-AC-2020	1 parallel Y, 2 collapsible tube (2m), 1 mask elbow, 2 end fittings 22F	10
CM-AC-2120	1 parallel Y, 2 collapsible tube (2m), 1 Kink free flexible catheter mount	10
CM-AC-2220	1 parallel Y, 2 collapsible tube (2m), 1 mask elbow, 2 end fittings 22F, 1 link tube (1.6m) 1 straight connector 22M/M	10
CM-AC-2320	1 parallel Y, 2 collapsible tube (2m), 1 Kink free flexible catheter mount, 2 end fittings 22F, 1 link tube (1.6m) 1 straight connector 22M/M	10
CM-AC-2420	1 parallel Y, 2 collapsible tube (2m), 1 collapsible catheter mount	10
Adult Anaesthesia Breathing Circuit (Flexi Tube)		
CM-AF-2020	1 parallel Y, 2 Flexi tube (2m), 1 mask elbow, 2 end fittings 22F	10
CM-AF-2120	1 parallel Y, 2 Flexi tube (2m), 1 Kink free flexible catheter mount	10
CM-AF-2220	1 parallel Y, 2 Flexi tube (2m), 1 mask elbow, 2 end fittings 22F, 1 Flexi link tube (1m) 1 straight connector 22M/M	10





















CM-AF-2320	1 parallel Y, 2 Flexi tube (2m), 1 Kink free flexible catheter mount, 2 end fittings 22F, 1 Flexi link tube (1m) 1 straight connector 22M/M		10
CM-AF-2220-2	1 parallel Y, 2 Flexi tube (2m), 1 mask elbow, 2 end fittings 22F, 1 Flexi link tube (2m) 1 straight connector 22M/M		10
CM-AF-2320-2	1 parallel Y, 2 Flexi tube (2m), 1 Kink free flexible catheter mount, 2 end fittings 22F, 1 Flexi link tube (2m) 1 straight connector 22M/M		10
Pediatric Breathing Circuit			
CM-AO-3018	1 parallel Y, 2 corrugated tube (1.8m), 1 mask elbow, 2 end fittings 15F		10
CM-AO-3118	1 parallel Y, 2 corrugated tube (1.8m), 1 Kink free flexible catheter mount, 2 end fittings 15F		10
CM-AO-3418	1 parallel Y, 2 corrugated tube (1.8m), 1 mask elbow, 2 end fittings 22F		10
CM-AO-3518	1 parallel Y, 2 corrugated tube (1.8m), 1 Kink free flexible catheter mount, 2 end fittings 22F		10
Bacterial / Viral Filter (HME)			
CM-AO-4000	Single use Adult Bacterial/viral filter WITH gas sampling port		50
CM-AO-4444	Single use Adult Bacterial/viral filter WITHOUT gas sampling port		50
CM-AO-9040	Single use Adult HME Filter WITH gas sampling port		50
CM-AO-9044	Single use Adult HME Filter WITHOUT gas sampling port		50
CM-AO-9060	Single use Paediatric Bacterial/Viral Filter with gas sampling port		50
CM-AO-9066	Single use Paediatric HME Filter with gas sampling port		50
CM-AO-1001	Single use bacterial/viral filter		50
Central Venous Pressure Monitoring Set (Medifix)			
CM-CVPM	Central Venous Pressure Monitoring Set (Medifix)		100
CM-CVPM	Central Venous Pressure Monitoring Set (Medifix) (Dual Layer)		100
Infusion Set (Intrafix)			
CM-IV-250	Infusion Set (Intrafix) length: 250cm		100
CM-IV-160-MTL	Infusion Set (Intrafix) (Dual Layer) length: 160cm		100
Opaque Infusion Set (Intrafix)			
CM-IVO	Opaque Infusion Set (Intrafix)		100
CM-IVO-MTL-AM	Opaque Infusion Set (Intrafix) Amber (Dual Layer)		100
Components			
CM-TPC-H5-020HG	Transducer Protector (strip of 4pcs)		400
CM-WYJ18	Needle Free Valve (strip of 5pcs)		500
CM-CS-R	Male/female luer lock stopper (red) (strip of 5) also known as combi red per strip of 5 pieces		500
Micro Drip			
CM-MDS-1	Micro Drip Set (Dosifix) (120ml burette)		50
CM-MDS	Opaque MicroDrip Set (Dosifix) (120ml burette)		50
CM-NF-MDS	Needle Free Opaque Micro Rip Set (Dosifix) (120ml burette)		50
Infusion Filter			
CM-CVPO-F	Opaque Infusion Set with fluid filter (Bacterial Fluid Filter)		100
CM-CVPO-F-MTL	Opaque Infusion Set with fluid filter (Bacterial Fluid Filter) (Dual Layer)		100
CM-OF-10	Opaque Infusion Filter for Infusion Therapy		100
CM-OF-10-MTL	Opaque Infusion Filter for Infusion Therapy (Dual Layer)		100
2 way/3 way Extension (LS2/LS3)			
CM-EY-4564BB	Extension Y (LS2) Connector		100
CM-EY-4564BB-MTL	Extension Y (LS2) Connector (Dual Layer)		100
CM-EY5564-2.5	Extension Y-Y (LS3) Connector 2.5mm		100
CM-EY5564-2.5-MTL	Extension Y-Y (LS3) Connector 2.5mm (Dual Layer)		100
CM-EY5564-4.0	Extension Y-Y (LS3) Connector 4.0mm		100
CM-EY5564-4.0-MTL	Extension Y-Y (LS3) Connector 4.0mm (Dual Layer)		100
Extension Tube (Heidelberg) our standard length is 140cm**			
CM-ET04-030	Extension Tube 4mm OD/ 3mm ID length 30cm		100
CM-ET04-075	Extension Tube 4mm OD/ 3mm ID length 75cm		100
CM-ET04-100	Extension Tube 4mm OD/ 3mm ID length 100cm		100
CM-ET04-140	Extension Tube 4mm OD/ 3mm ID length 140cm		100

Intra Venous (IV) / Infusion Related Items (STERILE)













































CM-ET04-200	Extension Tube 4mm OD/ 3mm ID length 200cm		100
CM-ET04-030-MTL	Extension Tube 4mm OD/ 3mm ID length 30cm (Dual Layer)		100
CM-ET04-075-MTL	Extension Tube 4mm OD/ 3mm ID length 75cm (Dual Layer)		100
CM-ET04-100-MTL	Extension Tube 4mm OD/ 3mm ID length 100cm (Dual Layer)		100
CM-ET04-140-MTL	Extension Tube 4mm OD/ 3mm ID length 140cm (Dual Layer)		100
CM-ET04-200-MTL	Extension Tube 4mm OD/ 3mm ID length 200cm (Dual Layer)		100
Extension Tubing with "T" Connector**			
CM-ETT-05	Extension Tubing with "T" Connector 5cm		100
CM-ETT-10	Extension Tubing with "T" Connector 10cm		100
CM-ETT-15	Extension Tubing with "T" Connector 15cm		100
Extension Tubing with "T" Luer Slip**			
CM-ETT-05-TLS	Extension Tubing with "T" Luer Slip 5cm		100
CM-ETT-10-TLS	Extension Tubing with "T" Luer Slip 10cm		100
CM-ETT-15-TLS	Extension Tubing with "T" Luer Slip 15cm		100
Fluid Management Tube**			
CM-FMT-100-Grn	Fluid Management Tube 100cm Green		100
CM-FMT-150-Grn	Fluid Management Tube 150cm Green		100
CM-FMT-200-Grn	Fluid Management Tube 200cm Green		100
CM-FMT-100-Org	Fluid Management Tube 100cm Orange		100
CM-FMT-150-Org	Fluid Management Tube 150cm Orange		100
CM-FMT-200-Org	Fluid Management Tube 200cm Orange		100
CM-FMT-100-Bei	Fluid Management Tube 100cm Beige		100
CM-FMT-150-Bei	Fluid Management Tube 150cm Beige		100
CM-FMT-200-Bei	Fluid Management Tube 200cm Beige		100
CM-FMT-100-Brw	Fluid Management Tube 100cm Brown		100
CM-FMT-150-Brw	Fluid Management Tube 150cm Brown		100
CM-FMT-200-Brw	Fluid Management Tube 200cm Brown		100
CM-FMT-100-Vlt	Fluid Management Tube 100cm Violet		100
CM-FMT-150-Vlt	Fluid Management Tube 150cm Violet		100
CM-FMT-200-Vlt	Fluid Management Tube 200cm Violet		100
3 way Stopcock (discifix)			
CM-B3	3 way Stopcock (Blue)		100
CM-R3	3 way Stopcock (Red)		100
CM-W3	3 Way Stopcock (White)		100
3 Way Stopcock with Extension Tube**			
CM-B3-ET02-05	BLUE 3 Way Stopcock with Extension Tube 2mm OD, 5cm		100
CM-B3-ET02-10	BLUE 3 Way Stopcock with Extension Tube 2mm OD, 10cm		100
CM-B3-ET02-15	BLUE 3 Way Stopcock with Extension Tube 2mm OD, 15cm		100
CM-B3-ET02-05B	BLUE 3 Way Stopcock with Extension Tube 2mm OD, 5cm (blue line)		100
CM-B3-ET02-10B	BLUE 3 Way Stopcock with Extension Tube 2mm OD, 10cm (blue line)		100
CM-B3-ET02-15B	BLUE 3 Way Stopcock with Extension Tube 2mm OD, 15cm (blue line)		100
CM-R3-ET02-05	RED 3 Way Stopcock with Extension Tube 2mm OD, 5cm		100
CM-R3-ET02-10	RED 3 Way Stopcock with Extension Tube 2mm OD, 10cm		100
CM-R3-ET02-15	RED 3 Way Stopcock with Extension Tube 2mm OD, 15cm		100
CM-W3-ET02-05	WHITE 3 Way Stopcock with Extension Tube 2mm OD, 5cm		100
CM-W3-ET02-10	WHITE 3 Way Stopcock with Extension Tube 2mm OD, 10cm		100
CM-W3-ET02-15	WHITE 3 Way Stopcock with Extension Tube 2mm OD, 15cm		100

Intra Venous (IV) / Infusion Related Items (STERILE)

STERILE)











CM-W3-ET02-05W	WHITE 3 Way Stopcock with Extension Tube 2mm OD, 5cm (white line)		100
CM-W3-ET02-10W	WHITE 3 Way Stopcock with Extension Tube 2mm OD, 10cm (white line)		100
CM-W3-ET02-15W	WHITE 3 Way Stopcock with Extension Tube 2mm OD, 15cm (white line)		100
CM-B3-ET03-05	BLUE 3 Way Stopcock with Extension Tube 3mm OD, 5cm		100
CM-B3-ET03-10	BLUE 3 Way Stopcock with Extension Tube 3mm OD, 10cm		100
CM-B3-ET03-15	BLUE 3 Way Stopcock with Extension Tube 3mm OD, 15cm		100
CM-B3-ET03-05B	BLUE 3 Way Stopcock with Extension Tube 3mm OD, 5cm (blue line)		100
CM-B3-ET03-10B	BLUE 3 Way Stopcock with Extension Tube 3mm OD, 10cm (blue line)		100
CM-B3-ET03-15B	BLUE 3 Way Stopcock with Extension Tube 3mm OD, 15cm (blue line)		100
CM-R3-ET03-05	RED 3 Way Stopcock with Extension Tube 3mm OD, 5cm		100
CM-R3-ET03-10	RED 3 Way Stopcock with Extension Tube 3mm OD, 10cm		100
CM-R3-ET03-15	RED 3 Way Stopcock with Extension Tube 3mm OD, 15cm		100
CM-W3-ET03-05	WHITE 3 Way Stopcock with Extension Tube 3mm OD, 5cm		100
CM-W3-ET03-10	WHITE 3 Way Stopcock with Extension Tube 3mm OD, 10cm		100
CM-W3-ET03-15	WHITE 3 Way Stopcock with Extension Tube 3mm OD, 15cm		100
CM-W3-ET03-05W	WHITE 3 Way Stopcock with Extension Tube 3mm OD, 5cm (white line)		100
CM-W3-ET03-10W	WHITE 3 Way Stopcock with Extension Tube 3mm OD, 10cm (white line)		100
CM-W3-ET03-15W	WHITE 3 Way Stopcock with Extension Tube 3mm OD, 15cm (white line)		100
CM-B3-ET04-05	BLUE 3 Way Stopcock with Extension Tube 4mm OD 5cm		100
CM-B3-ET04-10	BLUE 3 Way Stopcock with Extension Tube 4mm OD 10cm		100
CM-B3-ET04-15	BLUE 3 Way Stopcock with Extension Tube 4mm OD 15cm		100
CM-B3-ET04-05B	BLUE 3 Way Stopcock with Extension Tube 4mm OD 5cm (blue line)		100
CM-B3-ET04-10B	BLUE 3 Way Stopcock with Extension Tube 4mm OD 10cm (blue line)		100
CM-B3-ET04-15B	BLUE 3 Way Stopcock with Extension Tube 4mm OD 15cm (blue line)		100
CM-R3-ET04-05	RED 3 Way Stopcock with Extension Tube 4mm OD 5cm		100
CM-R3-ET04-10	RED 3 Way Stopcock with Extension Tube 4mm OD 10cm		100
CM-R3-ET04-15	RED 3 Way Stopcock with Extension Tube 4mm OD 15cm		100
CM-W3-ET04-05	WHITE 3 Way Stopcock with Extension Tube 4mm OD 5cm		100
CM-W3-ET04-10	WHITE 3 Way Stopcock with Extension Tube 4mm OD 10cm		100
CM-W3-ET04-15	WHITE 3 Way Stopcock with Extension Tube 4mm OD 15cm		100
CM-W3-ET04-05W	WHITE 3 Way Stopcock with Extension Tube 4mm OD 5cm (white line)		100
CM-W3-ET04-10W	WHITE 3 Way Stopcock with Extension Tube 4mm OD 10cm (white line)		100
CM-W3-ET04-15W	WHITE 3 Way Stopcock with Extension Tube 4mm OD 15cm (white line)		100
CM-B3-PT02-05	BLUE 3 Way Stopcock with Pressure Tube 2mm OD 5cm		100
CM-B3-PT02-10	BLUE 3 Way Stopcock with Pressure Tube 2mm OD 10cm		100
CM-B3-PT02-15	BLUE 3 Way Stopcock with Pressure Tube 2mm OD 15cm		100
CM-B3-PT02-05B	BLUE 3 Way Stopcock with Pressure Tube 2mm OD 5cm (blue line)		100
CM-B3-PT02-10B	BLUE 3 Way Stopcock with Pressure Tube 2mm OD 10cm (blue line)		100
CM-B3-PT02-15B	BLUE 3 Way Stopcock with Pressure Tube 2mm OD 15cm (blue line)		100
CM-R3-PT02-05	RED 3 Way Stopcock with Pressure Tube 2mm OD 5cm		100
CM-R3-PT02-10	RED 3 Way Stopcock with Pressure Tube 2mm OD 10cm		100
CM-R3-PT02-15	RED 3 Way Stopcock with Pressure Tube 2mm OD 15cm		100
CM-R3-PT02-05R	RED 3 Way Stopcock with Pressure Tube 2mm OD 5cm (red line)		100
CM-R3-PT02-10R	RED 3 Way Stopcock with Pressure Tube 2mm OD 10cm (red line)		100
CM-R3-PT02-15R	RED 3 Way Stopcock with Pressure Tube 2mm OD 15cm (red line)		100

elated Items (STERILE) Intra Venous (IV) / Infusion Related Items (











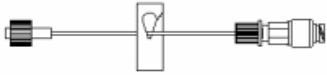
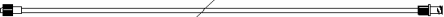

CM-W3-PT02-05	WHITE 3 Way Stopcock with Pressure Tube 2mm OD 5cm		100
CM-W3-PT02-10	WHITE 3 Way Stopcock with Pressure Tube 2mm OD 10cm		100
CM-W3-PT02-15	WHITE 3 Way Stopcock with Pressure Tube 2mm OD 15cm		100
CM-W3-PT02-05W	WHITE 3 Way Stopcock with Pressure Tube 2mm OD 5cm (white line)		100
CM-W3-PT02-10W	WHITE 3 Way Stopcock with Pressure Tube 2mm OD 10cm (white line)		100
CM-W3-PT02-15W	WHITE 3 Way Stopcock with Pressure Tube 2mm OD 15cm (white line)		100
CM-B3-PT03-05	BLUE 3 Way Stopcock with Pressure Tube 3mm OD 5cm		100
CM-B3-PT03-10	BLUE 3 Way Stopcock with Pressure Tube 3mm OD 10cm		100
CM-B3-PT03-15	BLUE 3 Way Stopcock with Pressure Tube 3mm OD 15cm		100
CM-B3-PT03-05B	BLUE 3 Way Stopcock with Pressure Tube 3mm OD 5cm (blue line)		100
CM-B3-PT03-10B	BLUE 3 Way Stopcock with Pressure Tube 3mm OD 10cm (blue line)		100
CM-B3-PT03-15B	BLUE 3 Way Stopcock with Pressure Tube 3mm OD 15cm (blue line)		100
CM-R3-PT03-05	RED 3 Way Stopcock with Pressure Tube 3mm OD 5cm		100
CM-R3-PT03-10	RED 3 Way Stopcock with Pressure Tube 3mm OD 10cm		100
CM-R3-PT03-15	RED 3 Way Stopcock with Pressure Tube 3mm OD 15cm		100
CM-R3-PT03-05R	RED 3 Way Stopcock with Pressure Tube 3mm OD 5cm (red line)		100
CM-R3-PT03-10R	RED 3 Way Stopcock with Pressure Tube 3mm OD 10cm (red line)		100
CM-R3-PT03-15R	RED 3 Way Stopcock with Pressure Tube 3mm OD 15cm (red line)		100
CM-W3-PT03-05	WHITE 3 Way Stopcock with Pressure Tube 3mm OD 5cm		100
CM-W3-PT03-10	WHITE 3 Way Stopcock with Pressure Tube 3mm OD 10cm		100
CM-W3-PT03-15	WHITE 3 Way Stopcock with Pressure Tube 3mm OD 15cm		100
CM-W3-PT03-05W	WHITE 3 Way Stopcock with Pressure Tube 3mm OD 5cm (white line)		100
CM-W3-PT03-10W	WHITE 3 Way Stopcock with Pressure Tube 3mm OD 10cm (white line)		100
CM-W3-PT03-15W	WHITE 3 Way Stopcock with Pressure Tube 3mm OD 15cm (white line)		100
CM-B3-PT04-05	BLUE 3 Way Stopcock with Pressure Tube 4mm OD 5cm		100
CM-B3-PT04-10	BLUE 3 Way Stopcock with Pressure Tube 4mm OD 10cm		100
CM-B3-PT04-15	BLUE 3 Way Stopcock with Pressure Tube 4mm OD 15cm		100
CM-B3-PT04-05B	BLUE 3 Way Stopcock with Pressure Tube 4mm OD 5cm (blue line)		100
CM-B3-PT04-10B	BLUE 3 Way Stopcock with Pressure Tube 4mm OD 10cm (blue line)		100
CM-B3-PT04-15B	BLUE 3 Way Stopcock with Pressure Tube 4mm OD 15cm (blue line)		100
CM-R3-PT04-05	RED 3 Way Stopcock with Pressure Tube 4mm OD 5cm		100
CM-R3-PT04-10	RED 3 Way Stopcock with Pressure Tube 4mm OD 10cm		100
CM-R3-PT04-15	RED 3 Way Stopcock with Pressure Tube 4mm OD 15cm		100
CM-R3-PT04-05R	RED 3 Way Stopcock with Pressure Tube 4mm OD 5cm (red line)		100
CM-R3-PT04-10R	RED 3 Way Stopcock with Pressure Tube 4mm OD 10cm (red line)		100
CM-R3-PT04-15R	RED 3 Way Stopcock with Pressure Tube 4mm OD 15cm (red line)		100
CM-W3-PT04-05	WHITE 3 Way Stopcock with Pressure Tube 4mm OD 5cm		100
CM-W3-PT04-10	WHITE 3 Way Stopcock with Pressure Tube 4mm OD 10cm		100
CM-W3-PT04-15	WHITE 3 Way Stopcock with Pressure Tube 4mm OD 15cm		100
CM-W3-PT04-05W	WHITE 3 Way Stopcock with Pressure Tube 4mm OD 5cm (white line)		100
CM-W3-PT04-10W	WHITE 3 Way Stopcock with Pressure Tube 4mm OD 10cm (white line)		100
CM-W3-PT04-15W	WHITE 3 Way Stopcock with Pressure Tube 4mm OD 15cm (white line)		100
	3 Way Stopcock with Extension Tubing for Infusion Therapy		
CM-3WB-ET02-05	BLUE 3 Way Stopcock with Extension Tube for Infusion Therapy 2mm OD 5cm		100
CM-3WB-ET02-10	BLUE 3 Way Stopcock with Extension Tube for Infusion Therapy 2mm OD 10cm		100

V) / Infusion Related Items (STERILE)

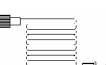

Intra Venous (IV) / Infusion R

CM-3WB-ET02-15	BLUE 3 Way Stopcock with Extension Tube for Infusion Therapy 2mm OD 15cm		100
CM-3WB-ET02-05B	BLUE 3 Way Stopcock with Extension Tube for Infusion Therapy 2mm OD 5cm (Blue Line)		100
CM-3WB-ET02-10B	BLUE 3 Way Stopcock with Extension Tube for Infusion Therapy 2mm OD 10cm (Blue Line)		100
CM-3WB-ET02-15B	BLUE 3 Way Stopcock with Extension Tube for Infusion Therapy 2mm OD 15cm (Blue Line)		100
CM-3WB-ET03-05	BLUE 3 Way Stopcock with Extension Tube for Infusion Therapy 3mm OD 5cm		
CM-3WB-ET03-10	BLUE 3 Way Stopcock with Extension Tube for Infusion Therapy 3mm OD 10cm	100	
CM-3WB-ET03-15	BLUE 3 Way Stopcock with Extension Tube for Infusion Therapy 3mm OD 15cm	100	
CM-3WB-ET03-05B	BLUE 3 Way Stopcock with Extension Tube for Infusion Therapy 3mm OD 5cm (Blue Line)		100
CM-3WB-ET03-10B	BLUE 3 Way Stopcock with Extension Tube for Infusion Therapy 3mm OD 10cm (Blue Line)		100
CM-3WB-ET03-15B	BLUE 3 Way Stopcock with Extension Tube for Infusion Therapy 3mm OD 15cm (Blue Line)		100
CM-3WB-ET04-05	BLUE 3 Way Stopcock with Extension Tube for Infusion Therapy 4mm OD 5cm		100
CM-3WB-ET04-10	BLUE 3 Way Stopcock with Extension Tube for Infusion Therapy 4mm OD 10cm		100
CM-3WB-ET04-15	BLUE 3 Way Stopcock with Extension Tube for Infusion Therapy 4mm OD 15cm		100
CM-3WB-ET04-05B	BLUE 3 Way Stopcock with Extension Tube for Infusion Therapy 4mm OD 5cm (Blue Line)		100
CM-3WB-ET04-10B	BLUE 3 Way Stopcock with Extension Tube for Infusion Therapy 4mm OD 10cm (Blue Line)		100
CM-3WB-ET04-15B	BLUE 3 Way Stopcock with Extension Tube for Infusion Therapy 4mm OD 15cm (Blue Line)		100
CM-3WB-PT02-05	BLUE 3 Way Stopcock with Pressure Tube for Infusion Therapy 2mm OD 5cm		100
CM-3WB-PT02-10	BLUE 3 Way Stopcock with Pressure Tube for Infusion Therapy 2mm OD 10cm		100
CM-3WB-PT02-15	BLUE 3 Way Stopcock with Pressure Tube for Infusion Therapy 2mm OD 15cm		100
CM-3WB-PT02-05B	BLUE 3 Way Stopcock with Pressure Tube for Infusion Therapy 2mm OD 5cm (Blue Line)		100
CM-3WB-PT02-10B	BLUE 3 Way Stopcock with Pressure Tube for Infusion Therapy 2mm OD 10cm (Blue Line)		100
CM-3WB-PT02-15B	BLUE 3 Way Stopcock with Pressure Tube for Infusion Therapy 2mm OD 15cm (Blue Line)		100
CM-3WB-PT03-05	BLUE 3 Way Stopcock with Pressure Tube for Infusion Therapy 3mm OD 5cm		100
CM-3WB-PT03-10	BLUE 3 Way Stopcock with Pressure Tube for Infusion Therapy 3mm OD 10cm		100
CM-3WB-PT03-15	BLUE 3 Way Stopcock with Pressure Tube for Infusion Therapy 3mm OD 15cm		100
CM-3WB-PT03-05B	BLUE 3 Way Stopcock with Pressure Tube for Infusion Therapy 3mm OD 5cm (Blue Line)		100
CM-3WB-PT03-10B	BLUE 3 Way Stopcock with Pressure Tube for Infusion Therapy 3mm OD 10cm (Blue Line)		100
CM-3WB-PT03-15B	BLUE 3 Way Stopcock with Pressure Tube for Infusion Therapy 3mm OD 15cm (Blue Line)		100
CM-3WB-PT04-05	BLUE 3 Way Stopcock with Pressure Tube for Infusion Therapy 4mm OD 5cm		100
CM-3WB-PT04-10	BLUE 3 Way Stopcock with Pressure Tube for Infusion Therapy 4mm OD 10cm		100
CM-3WB-PT04-15	BLUE 3 Way Stopcock with Pressure Tube for Infusion Therapy 4mm OD 15cm		100
CM-3WB-PT04-05B	BLUE 3 Way Stopcock with Pressure Tube for Infusion Therapy 4mm OD 5cm (Blue Line)		100
CM-3WB-PT04-10B	BLUE 3 Way Stopcock with Pressure Tube for Infusion Therapy 4mm OD 10cm (Blue Line)		100
CM-3WB-PT04-15B	BLUE 3 Way Stopcock with Pressure Tube for Infusion Therapy 4mm OD 15cm (Blue Line)		100
	Minimal Volume**		
CM-MV-30	Minimal Volume Extension Tube 30		200
CM-MV-50	Minimal Volume Extension Tube 50		200
CM-MV-75	Minimal Volume Extension Tube 75		200
CM-MV-100	Minimal Volume Extension Tube 100		200
CM-MV-150	Minimal Volume Extension Tube 150		200
CM-MV-200	Minimal Volume Extension Tube 200		200
	Needle Free		
CM-NFIV	Needle Free IV Set		100
CM-NFIV-MTL	Needle Free IV Set (Dual Layer)		100
CM-NFIV-160407	Needle Free IV Set with Rotating MLL and Slip Clip		100
CM-NF-LS3	Needle Free 3 Way Connector with Rotating Luer Lock		100

Intra Veneous (I)

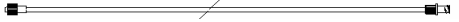
CM-WYJ18-ET5	Needle Free Extension Tube** Needle Free Extension Tube 5cm		100
CM-WYJ18-ET10	Needle Free Extension Tube 10cm		100
CM-WYJ18-ET15	Needle Free Extension Tube 15cm		100
Perfusion Tube also known as syringe pump tubing**			
CM-PT-100	Perfusion Tube 100cm (clear)		100
CM-PT-150	Perfusion Tube 150cm (clear)		100
CM-PT-200	Perfusion Tube 200cm (clear)		100
CM-PT-100-MTL	Perfusion Tube 100cm (clear) (Dual Layer)		100
CM-PT-150-MTL	Perfusion Tube 150cm (clear) (Dual Layer)		100
CM-PT-200-MTL	Perfusion Tube 200cm (clear) (Dual Layer)		100
CM-PT-100B	Perfusion Tube 100cm with UV protection (black)		100
CM-PT-150B	Perfusion Tube 150cm with UV protection (black)		100
CM-PT-200B	Perfusion Tube 200cm with UV protection (black)		100
CM-PT-100-MTL-B	Perfusion Tube 100cm with UV protection (black) (Dual Layer)		100
CM-PT-150-MTL-B	Perfusion Tube 150cm with UV protection (black) (Dual Layer)]		100
CM-PT-200-MTL-B	Perfusion Tube 200cm with UV protection (black) (Dual Layer)		100
CM-PT-100-AM	Perfusion Tube 100cm with UV protection (amber)		100
CM-PT-150-AM	Perfusion Tube 150cm with UV protection (amber)		100
CM-PT-200-AM	Perfusion Tube 200cm with UV protection (amber)		100
CM-PT-100-MTL-AM	Perfusion Tube 100cm with UV protection (amber) (Dual Layer)		100
CM-PT-150-MTL-AM	Perfusion Tube 150cm with UV protection (amber) (Dual Layer)		100
CM-PT-200-MTL-AM	Perfusion Tube 200cm with UV protection (amber) (Dual Layer)		100
CM-SPT-100	Perfusion Tube 100cm spiral		100
CM-SPT-150	Perfusion Tube 150cm spiral		100
CM-SPT-200	Perfusion Tube 200cm spiral		100
CM-SPT-100B	Perfusion Tube 100cm spiral UV protection (black)		100
CM-SPT-150B	Perfusion Tube 150cm spiral UV protection (black)		100
CM-SPT-200B	Perfusion Tube 200cm spiral UV protection (black)		100
Pressure Monitoring Tube**			
KMS-PMT-MF-100B	Pressure Monitoring tubing 100cm Blue (male/female)		100
KMS-PMT-MF-150B	Pressure Monitoring tubing 150cm Blue (male/female)		100
KMS-PMT-MF-200B	Pressure Monitoring tubing 200cm Blue (male/female)		100
KMS-PMT-MF-100R	Pressure Monitoring tubing 100cm Red (male/female)		100
KMS-PMT-MF-150R	Pressure Monitoring tubing 150cm Red (male/female)		100
KMS-PMT-MF-200R	Pressure Monitoring tubing 200cm Red (male/female)		100
CM-PMT-MF-100Y	Pressure Monitoring tubing 100cm Yellow (male/female)		100
CM-PMT-MF-150Y	Pressure Monitoring tubing 150cm Yellow (male/female)		100
CM-PMT-MF-200Y	Pressure Monitoring tubing 200cm Yellow (male/female)		100
CM-PMT-MM-100B	Pressure Monitoring tubing 100cm Blue (male/male)		100
CM-PMT-MM-150B	Pressure Monitoring tubing 150cm Blue (male/male)		100
CM-PMT-MM-200B	Pressure Monitoring tubing 200cm Blue (male/male)		100
CM-PMT-MM-100R	Pressure Monitoring tubing 100cm Red (male/male)		100
CM-PMT-MM-150R	Pressure Monitoring tubing 150cm Red (male/male)		100
CM-PMT-MM-200R	Pressure Monitoring tubing 200cm Red (male/male)		100
CM-PMT-MM-100Y	Pressure Monitoring tubing 100cm Yellow (male/male)		100

	CM-PMT-MM-150Y	Pressure Monitoring tubing 150cm Yellow (male/male)		100
	CM-PMT-MM-200Y	Pressure Monitoring tubing 200cm Yellow (male/male)		100
	CM-PMT-MF-100	Pressure Monitoring tubing 100cm clear (male/female)		100
	CM-PMT-MF-150	Pressure Monitoring tubing 150cm clear (male/female)		100
	CM-PMT-MF-200	Pressure Monitoring tubing 200cm clear (male/female)		100

(NON-STERILE)	Oxygen Nasal Cannula			
	CM-NC-6111	Adult Nasal Cannula (6ft)		100
	CM-NC-6113	Pediatric Nasal Cannula (6ft)		100
	CM-NC-6114	Infant Nasal Cannula (6ft)		100
	CM-NC-6115	Neonatal Nasal Cannula (6ft)		100
	CM-NC-6183	6ft Oxygen Supply Tubing**		100
	CM-NC-200	2 Meters Oxygen Supply Tubing**		100
	CM-NC-6111-CO2	Adult Nasal Cannula (6ft) with CO2 sampling port		50
	CM-NC-0111	Adult Nasal Cannula(With Male connector)		50
	CM-NC-0113	Pediatric Nasal Cannula (With Male connector)		50
	CM-NC-0114	Infant Nasal Cannula (With Male connector)		50
	CM-NC-0115	Neonatal Nasal Cannula (With Male connector)		50
SAMPLING LINE				
	CM-CO2-MM300	CO2 sampling line-3 meter with male male connector		100
	CM-CO2-MM600	CO2 sampling line-6 meter with male male connector		100

(STERILE)	Nelaton/Urethral Catheter			
	CM-NT18-06	FG 06 (Female) 18cm Nelaton Catheter		100
	CM-NT18-08	FG 08 (Female) 18cm Nelaton Catheter		100
	CM-NT18-10	FG 10 (Female) 18cm Nelaton Catheter		100
	CM-NT18-12	FG 12 (Female) 18cm Nelaton Catheter		100
	CM-NT18-14	FG 14 (Female) 18cm Nelaton Catheter		100
	CM-NT18-16	FG 16 (Female) 18cm Nelaton Catheter		100
	CM-NT18-18	FG 18 (Female) 18cm Nelaton Catheter		100
	CM-NT40-06	FG 06 (Male) 40cm Nelaton Catheter		100
	CM-NT40-08	FG 08 (Male) 40cm Nelaton Catheter		100
	CM-NT40-10	FG 10 (Male) 40cm Nelaton Catheter		100
	CM-NT40-12	FG 12 (Male) 40cm Nelaton Catheter		100
	CM-NT40-14	FG 14 (Male) 40cm Nelaton Catheter		100
	CM-NT40-16	FG 16 (Male) 40cm Nelaton Catheter		100
	CM-NT40-18	FG 18 (Male) 40cm Nelaton Catheter		100
	Pre-Lubricated (Gel coated) Nelaton/Urethral Catheter			
	CM-NT18-06-G	Pre-Lubricated (Gel coated) FG 06 (Female) 18cm Nelaton Catheter		100
	CM-NT18-08-G	Pre-Lubricated (Gel coated) FG 08 (Female) 18cm Nelaton Catheter		100
	CM-NT18-10-G	Pre-Lubricated (Gel coated) FG 10 (Female) 18cm Nelaton Catheter		100
	CM-NT18-12-G	Pre-Lubricated (Gel coated) FG 12 (Female) 18cm Nelaton Catheter		100
	CM-NT18-14-G	Pre-Lubricated (Gel coated) FG 14 (Female) 18cm Nelaton Catheter		100
	CM-NT18-16-G	Pre-Lubricated (Gel coated) FG 16 (Female) 18cm Nelaton Catheter		100
	CM-NT18-18-G	Pre-Lubricated (Gel coated) FG 18 (Female) 18cm Nelaton Catheter		100
	CM-NT40-06-G	Pre-Lubricated (Gel coated) FG 06 (Male) 40cm Nelaton Catheter		100
	CM-NT40-08-G	Pre-Lubricated (Gel coated) FG 08 (Male) 40cm Nelaton Catheter		100
	CM-NT40-10-G	Pre-Lubricated (Gel coated) FG 10 (Male) 40cm Nelaton Catheter		100
	CM-NT40-12-G	Pre-Lubricated (Gel coated) FG 12 (Male) 40cm Nelaton Catheter		100
CM-NT40-14-G	Pre-Lubricated (Gel coated) FG 14 (Male) 40cm Nelaton Catheter		100	
CM-NT40-16-G	Pre-Lubricated (Gel coated) FG 16 (Male) 40cm Nelaton Catheter		100	
CM-NT40-18-G	Pre-Lubricated (Gel coated) FG 18 (Male) 40cm Nelaton Catheter		100	

	CM-RT90-06	Ryles/Stomach/Levin's Tube FG 06 Stomach Tube 90cm		100
--	------------	--	---	-----

(STERILE)	CM-RT120-08	FG 08 Stomach Tube 120cm		100	
	CM-RT120-10	FG 10 Stomach Tube 120cm		100	
	CM-RT120-12	FG 12 Stomach Tube 120cm		50	
	CM-RT120-14	FG 14 Stomach Tube 120cm		50	
	CM-RT120-16	FG 16 Stomach Tube 120cm		50	
	CM-RT120-18	FG 18 Stomach Tube 120cm		50	
	CM-RT120-20	FG 20 Stomach Tube 120cm		50	
	Pre-Lubricated (Gel coated) Ryles/Stomach/Levin's Tube				
	CM-RT90-06-G	Pre-Lubricated (Gel coated) FG 06 Stomach Tube 90cm			100
	CM-RT120-08-G	Pre-Lubricated (Gel coated) FG 08 Stomach Tube 120cm			100
CM-RT120-10-G	Pre-Lubricated (Gel coated) FG 10 Stomach Tube 120cm	100			
CM-RT120-12-G	Pre-Lubricated (Gel coated) FG 12 Stomach Tube 120cm	50			
CM-RT120-14-G	Pre-Lubricated (Gel coated) FG 14 Stomach Tube 120cm	50			
CM-RT120-16-G	Pre-Lubricated (Gel coated) FG 16 Stomach Tube 120cm	50			
CM-RT120-18-G	Pre-Lubricated (Gel coated) FG 18 Stomach Tube 120cm	50			
CM-RT120-20-G	Pre-Lubricated (Gel coated) FG 20 Stomach Tube 120cm	50			
(STERILE)	Suction Connecting Tube				
	CM-CT-100	100cm Connecting Tube		50	
	CM-CT-150	150cm Connecting Tube		50	
	CM-CT-200	200cm Connecting Tube		50	
	CM-CT-250	250cm Connecting Tube		50	
	CM-CT-300	300cm Connecting Tube		50	
	CM-CTDW-100	100cm Double Wrapped Connecting Tube		50	
	CM-CTDW-150	150cm Double Wrapped Connecting Tube		50	
	CM-CTDW-200	200cm Double Wrapped Connecting Tube		50	
	CM-CTDW-250	250cm Double Wrapped Connecting Tube		50	
CM-CTDW-300	300cm Double Wrapped Connecting Tube	50			
(NON-STERILE)	Suction Yankeur				
	CM-YKA	Adult sized Yankeur blue tip- non vented		100	
	CM-YKA-V	Adult sized Yankeur blue tip- vented		100	
	CM-YKA-1	Adult sized Yankeur plain tip- non vented		100	
	CM-YKA-1-V	Adult sized Yankeur plain tip- vented		100	
	CM-YKA-B	Adult sized Yankeur bulb tip- non vented		100	
	CM-YKA-B-V	Adult sized Yankeur bulb tip- vented		100	
	CM-YKP	Pediatrics sized Yankeur plain tip- non vented		100	
	CM-YKP-V	Pediatrics sized Yankeur plain tip - vented		100	
	Rectal Tube				
CM-RT-18	Rectal Tube FG18 40cm	100			
CM-HL-S	Rectal Tube for Colon Hydrotherapy Use (Large)	100			
CM-HL-L	Rectal Tube for Colon Hydrotherapy Use (Large)	100			
STERILE	Throca				
	CM-TC-28	Thoracic Catheter with trocar FG28		50	
	CM-TC-30	Thoracic Catheter with trocar FG30		50	
	CM-TC-28-C	Thoracic Catheter without trocar FG28		50	
	CM-TC-30-C	Thoracic Catheter without trocar FG30		50	
OTHERS					
CM-UBC	urine bag connector -20cm	100			
	Pump tubing male luer slip-30cm	100			
remark	** Customizable length				